

PRODUCT GUIDE

Hollow Shaft Encoder - VLP Product Line



Table of Contents

1.	VLP Series Encoders	4
2.	Ordering Code	5
3.	Technical Specifications	6-7
4.	Cable Options	8
5.	Installation Flew Chart	9
6.	Storage and Handling	10
7.	ESD Protection	10
8.	Electric Encoder Software Installation	10
8.1	Minimum requirements	10
8.2	Installing the software	10
9.	Electrical Connection	11-14
9.1	Absolute position over SSi or BiSS-C	11
9.2	Digital SSi Interface	12
9.3	Digital BiSS-C Interface	13
9.4	Setup mode over NCP (Netzer Communication Protocol)	14
9.5	Electrical connection and grounding	14
10.	Signal Verification	15-17
10.1	Starting the Encoder Explorer	15
10.2	Signal verification process	16
11.	Calibration	18-26
11.1	Auto-calibration	18
11.2	Manual calibration	21
11.3	Setting the encoder zero-position	25
11.4	Jitter test	26
12.	Operational Mode	27
12.1	SSi / BiSS	27

1. VLP Series Encoders

Netzer Precision Position Sensors has long been a trailblazer in the field of precision encoders, redefining the standards of motion control technology with unparalleled innovation and engineering expertise. Among its groundbreaking product families, the VLP series stands out as a true embodiment of technological advancement, reliability, and versatility. Designed with cutting-edge capacitive technology and a holistic approach to position sensing, the VLP encoders deliver exceptional precision, durability, and adaptability across a wide spectrum of applications, making them the preferred choice for industries demanding high performance and uncompromising accuracy.

Unlike conventional single or dual read-head systems, the VLP family employs a revolutionary holistic design, capturing position data across the entire surface of the encoder. This approach provides unmatched accuracy and resolution by eliminating localized errors and ensuring a more stable and reliable signal. Engineered to excel in the most challenging environments, these encoders demonstrate exceptional resilience against temperature extremes, vibrations, and electromagnetic interference (EMI). The lightweight, compact, and contactless design not only enhances durability and reduces maintenance but also positions the VLP family as the optimal choice for demanding applications in aerospace, robotics, defense, and medical devices.

Netzer's holistic design philosophy sets the VLP series apart as more than just a product line - it's a transformative innovation that redefines motion control. By delivering seamless integration capabilities and a superior approach to position sensing, the VLP encoders empower engineers to tackle complex challenges with unprecedented ease and precision. The VLP family encapsulates Netzer's commitment to excellence, offering a complete solution for industries that demand not only technical superiority but also long-term reliability and value.

Unique Values



HIGH PRECISION



LOW PROFILE



ISO 13485



MTBF 15 YEARS



EXTENDED
TEMP RANGE



NO CALIBRATION
ON POWER UP

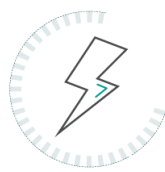

RESISTANCE TO
ELECTRIC SHOCKS



REPEATABILITY

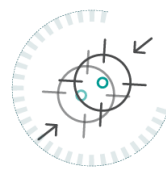

WIDE MOUNTING
TOLERANCE

2. Ordering Code



VLP Product Line

Outer Diameter (mm)
13, 25, 35, 60, 80, 100, 140, 170, 247

Output
S SSi
I BiSS

Resolution		
Code	bit	CPR
C	14	16,384
D	15	32,768
E	16	65,356
F	17	131,072
G	18	262,144
H	19	524,288
I	20	1,048,576
J	21*	2,097,152
K	22*	4,194,304
L	23*	8,388,608

VLP-13	14-18 bit
VLP-25	17-21 bit
VLP-35	17-19 bit
VLP-60, 100, 247	17-22 bit
VLP-80, 140, 170	17-23 bit
* SSi only	

BIT (Built In Test): Optional
[] None
B BIT

Shaft-turn Counter*
(Not for VLP-35)
[] None
S11 2,048
S12 4,096
S13 8,192
S14 16,384

Custom

Coating
[] None (Acrylic conformal)
P Parylene

Rotor Type (Only for VLP-25)
E End Shaft - Single Screw
I Hollow Shaft with insert
Rotor Type (Only for VLP-35)
H Hollow Shaft Encoder
1 End Shaft - Single Screw

Cable Length
0 250 mm Flying leads - 30AWG
1 500 mm Flying leads - 30AWG
2 750 mm Flying leads - 30AWG
3 1000 mm Flying leads - 30AWG
4 250 mm Flying leads - 28AWG
5 500 mm Flying leads - 28AWG
6 750 mm Flying leads - 28AWG
7 1000 mm Flying leads - 28AWG
To add a connector contact us

Cable Options
S Jacket and shielded cable
B Shielded cable
W Wires only
N ESA Space cable

* The combination of Resolution and Shaft-turn Counter should not exceeded more than 32 bit (at SSi).

3. Technical Specifications

Electrical

Supply voltage	Current consumption	Communication	Clock frequency	Material (stator / rotor)
5V ±5%	~110 mA	SSI, BiSS-C	0.1- 5.0 MHz	PCB (FR4)

Environment

EMC	Operating temp.	Storage temp.	Relative humidity	Built In Test BIT
IEC 6100-6-2, IEC 6100-6-4	-40° C to +105° C	-55° C to +125° C	98% Non condensing	Optional
Protection	Vibration		Shock	
IP 40	20g @ 10 to 2000 Hz sweep per IEC 60068-2-6		100g 6msec saw-tooth per IEC 60068-2-27:2009	

VLP-13



OD / ID mm	Height mm	Weight gr.	Resolution	Accuracy	Rotor inertia
13.5 / -	10.9	2	14-18 bit	±0.15°	15.56 gr · mm ²
Repeatability		Max. Operational speed		Position update rate	
2.6 mdeg / 9.4 Arcsec		6,000 rpm		35 kHz	

VLP-25



OD / ID mm	Height mm	Weight gr.	Resolution	Accuracy	Rotor inertia
25 / 2.2*	5.8	8	17-21 bit	±0.025°	37 gr · mm ²
Repeatability		Max. Operational speed		Position update rate	
2.6 mdeg / 9.4 Arcsec		6,000 rpm		35 kHz	

* Optional Shaft End

VLP-35



OD / ID mm	Height mm	Weight gr.	Resolution	Accuracy	Rotor inertia
35 / 11*	6.2	10.4	17-19 bit	±0.035°	170 gr · mm ²
Repeatability		Max. Operational speed		Position update rate	
2.7 mdeg / 9.9 Arcsec		4,000 rpm		28 kHz (Optional - 375 kHz)	

* Optional Shaft End

VLP-60



OD / ID mm	Height mm	Weight gr.	Resolution	Accuracy	Rotor inertia
59.7 / 25	5.3	16	17-22 bit	±0.010°	2,100 gr · mm ²
Repeatability		Max. Operational speed		Position update rate	
1.4 mdeg / 4.9 Arcsec		4,000 rpm		35 kHz (Optional - 375 kHz)	



VLP-80

OD / ID mm	Height mm	Weight gr.	Resolution	Accuracy	Rotor inertia
80 / 35	6.6	21	17-23 bit	±0.006°	9,600 gr · mm ²
Repeatability		Max. Operational speed		Position update rate	
0.7 mdeg / 2.5 Arcsec		2,000 rpm		35 kHz (Optional - 375 kHz)	

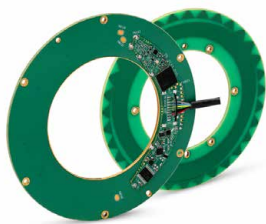

VLP-100

OD / ID mm	Height mm	Weight gr.	Resolution	Accuracy	Rotor inertia
100 / 48	6.2	42	17-22 bit	±0.006°	17,900 gr · mm ²
Repeatability		Max. Operational speed		Position update rate	
0.7 mdeg / 2.5 Arcsec		4,000 rpm		35 kHz (Optional - 375 kHz)	

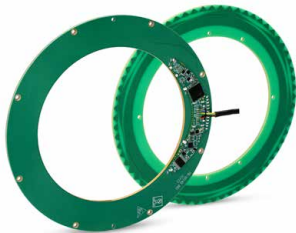

VLP-140

OD / ID mm	Height mm	Weight gr.	Resolution	Accuracy	Rotor inertia
140 / 90	7	80	17-23 bit	±0.006°	88,500 gr · mm ²
Repeatability		Max. Operational speed		Position update rate	
0.7 mdeg / 2.5 Arcsec		2,000 rpm		35 kHz (Optional - 375 kHz)	



VLP-170

OD / ID mm	Height mm	Weight gr.	Resolution	Accuracy	Rotor inertia
170 / 110	7	110	17-23 bit	±0.006°	205,000 gr · mm ²
Repeatability		Max. Operational speed		Position update rate	
0.7 mdeg / 2.5 Arcsec		2,000 rpm		35 kHz (Optional - 375 kHz)	



VLP-247

OD / ID mm	Height mm	Weight gr.	Resolution	Accuracy	Rotor inertia
247.7 / 171.4	7.8	220	17-22 bit	±0.006°	876,000 gr · mm ²
Repeatability		Max. Operational speed		Position update rate	
1.4 mdeg / 4.9 Arcsec		4,000 rpm		35 kHz (Optional - 375 kHz)	

NOTE: Technical data might change from time to time, please refer to website. Specific data concerning mounting and tolerances can be found on website in the technical drawings.

4. Cable Options

Cable options

Netzer Cat No.	CB 00014-A	CB 00034
Cable type	30 AWG twisted pair x 3	28 AWG twisted pair x 3
Wire type	2 x 30 AWG tinned copper Insulation: Ø 0.15 FEP OD: Ø 0.6 ± 0.05 mm	2 x 30 AWG tinned copper Insulation: PFA Ø 0.12 OD: Ø 0.64 ± 0.05 mm
Braided shield	Thinned copper braided 95% min. coverage	
Jacket	0.45 TPE	0.44 silicon rubber (NFA 11-A1)
Diameter	Ø 3.4 ± 0.16 mm	Ø 3.53 ± 0.16 mm

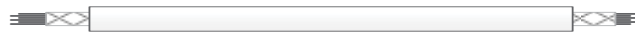
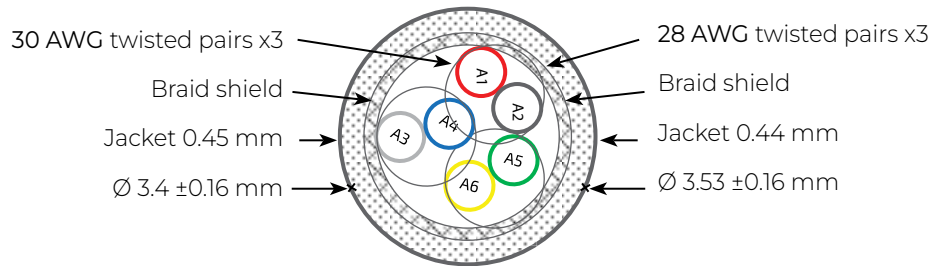

Pair#	Color
A1-A2	Red / Black
A3-A4	Gray / Blue
A5-A6	Green / Yellow

5. Installation Flow Chart

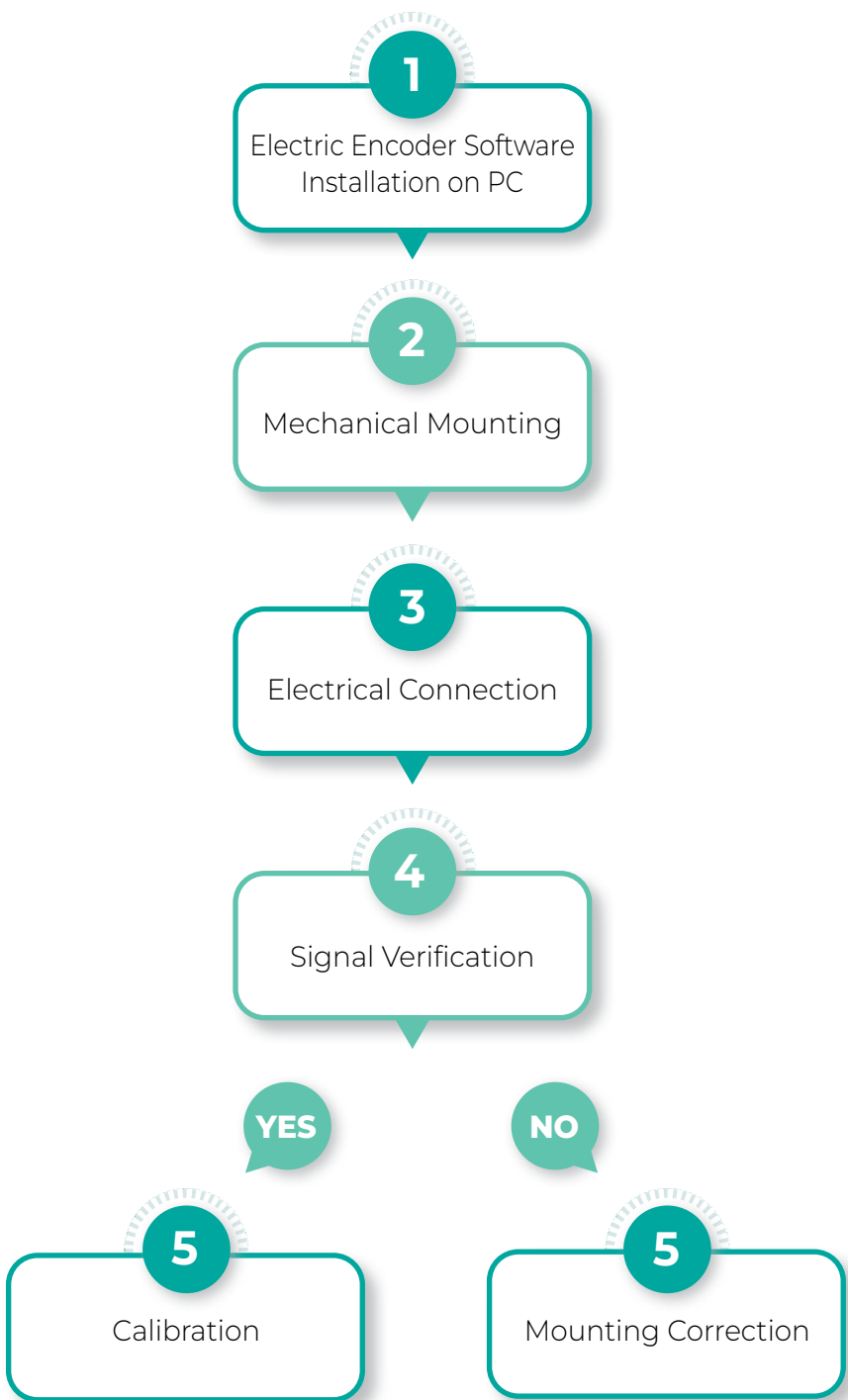

6. Storage and Handling

Storage temperature: -55°C to +125 °C

Humidity: up to 98% non-condensing

7. ESD Protection

As usual for electronic circuits, during product handling do not touch electronic circuits, wires, connectors or sensors without suitable ESD protection. The integrator / operator shall use ESD equipment to avoid the risk of circuit damage.



ATTENTION!

**OBSERVE PRECAUTIONS FOR HANDLING
ELECTROSTATIC SENSITIVE DEVICES**

8. Electric Encoder Software Installation



The Electric Encoder Explorer (EEE) software:

- Verifies correct mounting for an adequate signal amplitude
- Calibration of offsets
- General set up and signal analysis

This section describes the steps associated with installing the EEE software application.

8.1 Minimum requirements

- Operating system: MS windows 7/10, (32 / 64 bit)
- Memory: 4MB minimum
- Communication ports: USB 2
- Windows .NET Framework, V4 minimum

8.2 Installing the software

- Run the Electric Encoder™ Explorer file found on Netzer website: [Encoder Explorer Software Tools](#).
- After the installation you will see Electric Encoder Explorer software icon on the computer desktop.
- Double click on the Electric Encoder Explorer software icon to start.

9. Electrical Connection

This chapter reviews the steps required to electrically connect the encoder with digital interface (SSi or BiSS-C).

Connecting the encoder

The encoder has two operational modes:

9.1 Absolute position over SSi or BiSS-C

This is the power-up default mode

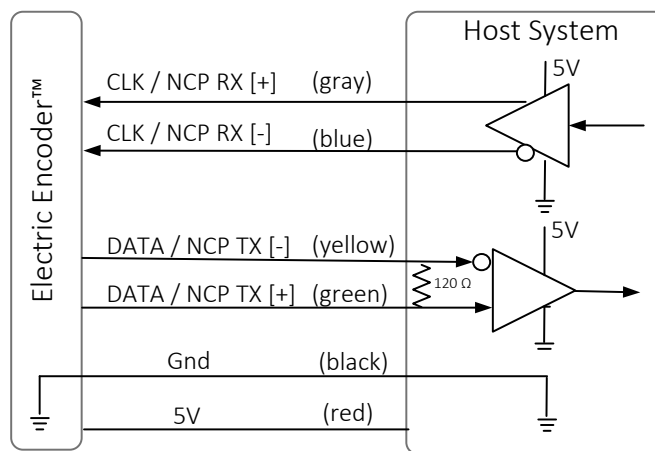

SSi / BiSS interface wires color code

Clock +	Grey	Clock
Clock -	Blue	
Data -	Yellow	Data
Data +	Green	
GND	Black	Ground
+5V	Red	Power supply

SSi / BiSS output signal parameters

Output code	Binary
Serial output	Differential RS-422
Clock	Differential RS-422
Clock frequency	0.1 ÷ 5.0 MHz
Position update rate	35 kHz (Optional - up to 375 kHz)

9.2 Digital SSI Interface



Synchronous Serial Interface (SSI) is a point to point serial interface standard between a master (e.g. controller) and a slave (e.g. sensor) for digital data transmission.

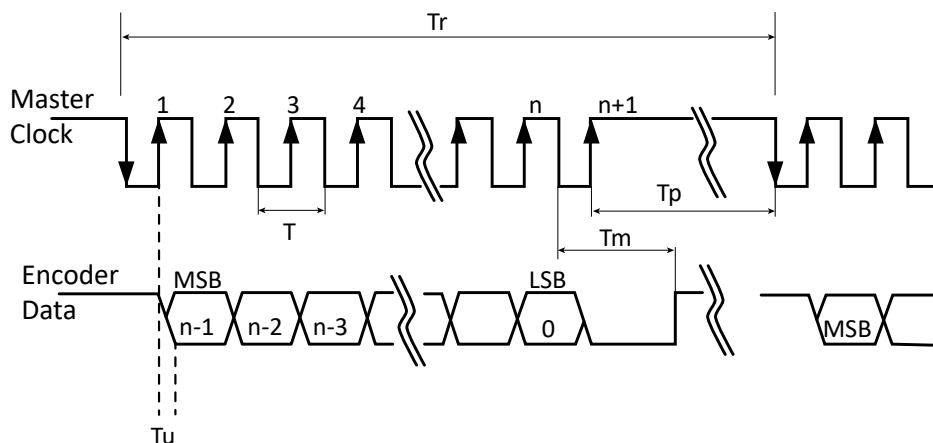

Built In Test option (BIT)

The BIT indicates critical abnormality in the encoder internal signals.

'0' – the internal signals are within the normal limits, '1' – Error

The Part Number of the encoder indicates whether the encoder includes BIT. If no BIT is indicated in the PN, there is no additional error bit.

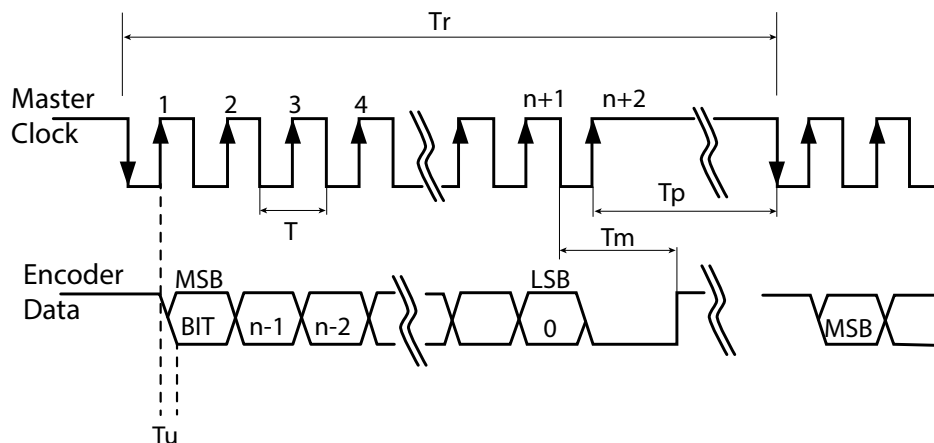

	Description	Recommendations
n	*Position resolution	12-23
T	Clock period	
$f = 1/T$	Clock frequency	0.1-5.0 MHz
Tu	Bit update time	90 nsec
Tp	Pause time	26 - ∞ μsec
Tm	Monoflop time	25 μsec
Tr	Time between 2 adjacent requests	$Tr > n * T + 26 \mu\text{sec}$
$fr = 1/Tr$	Data request frequency	

*Position resolution consistent with the resolution of the ordered encoder.

9.3 Digital BiSS-C Interface

BiSS-C Interface is unidirectional serial synchronous protocol for digital data transmission where the Encoder acts as “slave” transmits data according to “Master” clock. The BiSS protocol is designed in B mode and C mode (continuous mode). The BiSS-C interface as the SSi is based on RS-422 standards.

Built In Test option (BIT)

The BIT indicates critical abnormality in the encoder internal signals.

'1' – the internal signals are within the normal limits, '0' – Error

The Part Number of the encoder indicates whether the encoder includes BIT. If no BIT is indicated in the PN, the error bit is always 1.

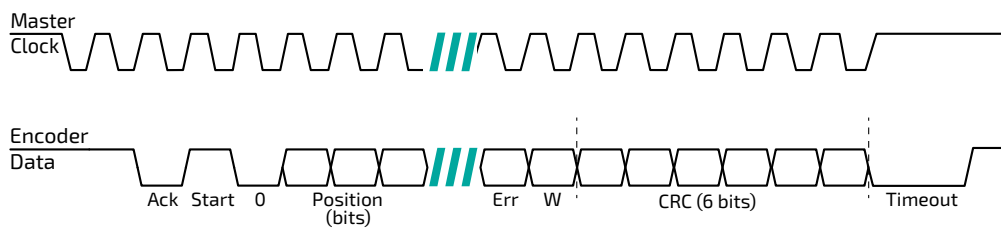

Bit allocation per encoder-resolution				Description		Default	Length
17bit	18bit	19bit	20bit				
27	28	29	30	Ack	Period during which the encoder calculates the absolute position, one clock cycle	0	1/clock
26	27	28	29	Start	Encoder signal for “start” data transmit	1	1 bit
25	26	27	28	“0”	“Start” bit follower	0	1 bit
8...24	8...25	8...26	8...27	AP	Absolute Position encoder data		Per resolution
7	7	7	7	Error	BIT (Built In Test option)	1	1 bit
6	6	6	6	Warn.	Warning (non active)	1	1 bit
0...5	0...5	0...5	0...5	CRC	The CRC polynomial for position, error and warning data is: $x^6 + x^1 + x^0$. It is transmitted MSB first and inverted. The start bit and “0” bit are omitted from the CRC calculation.		6 bits
				Timeout	Elapse between the sequential “start”request cycle’s		25 µs

9.4 Setup mode over NCP (Netzer Communication Protocol)

This service mode provides access via USB to a PC running Netzer Encoder Explorer application (on MS Windows 7/10). Communication is via Netzer Communication Protocol (NCP) over RS-422 using the same set of wires.

Use the following pin assignment to connect the encoder to a 9-pin D-type connector to the RS-422/USB converter CNV-0003 or the NanoMIC.

Electric encoder interface, D Type 9 pin Female

Description	Color	Function	Pin No
SSi Clock / NCP RX	Gray	Clock / RX +	2
	Blue	Clock / RX -	1
SSi Data / NCP TX	Yellow	Data / TX -	4
	Green	Data / TX +	3
Ground	Black	GND	5
Power supply	Red	+5V	8

Connect Netzer encoder to the converter, connect the converter to the computer and run the Electric Encoder Explorer Software Tool.

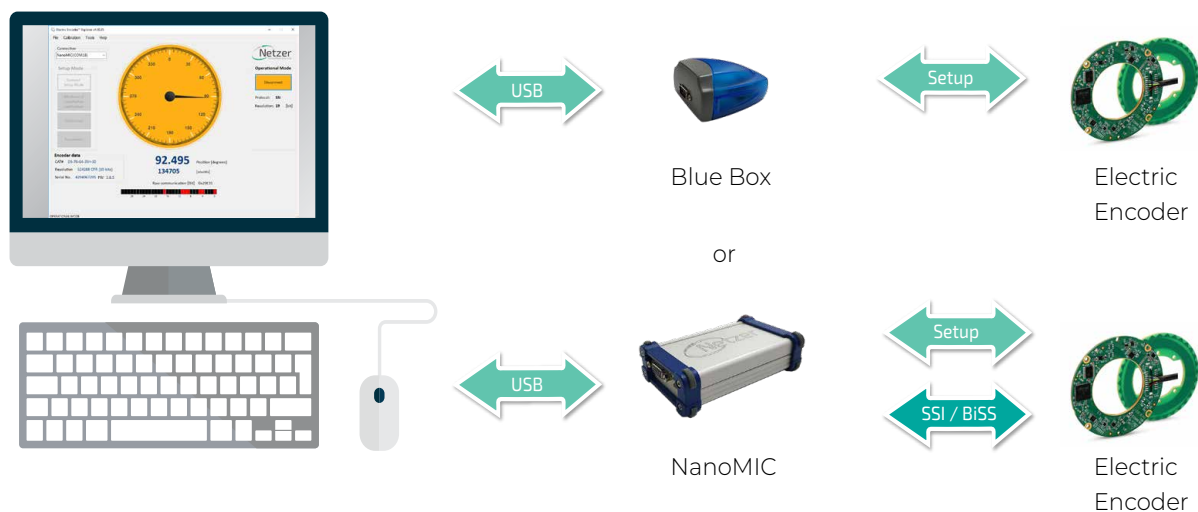

9.5 Electrical connection and grounding

Observe the following grounding consideration:

1. The cable shield is not grounded by default. (Optional accessories items)
2. Make sure the chassis is grounded.
3. It's highly recommended to keep the motor PWM wires electrically shielded and/or kept away from the encoder.

Note: 4.75 to 5.25 VDC power supply required

10. Signal Verification

10.1 Starting the Encoder Explorer

Make sure to complete the following tasks successfully:

- Mechanical Mounting
- Electrical Connection to the encoder
- Encoder Explore Software Installation

Run the Encoder Explorer tool (EE)

Ensure proper communication with the encoder: (Setup mode by default).

The Encoder position-dial is colored blue when in Setup Mode, either through the NanoMic or the BlueBox (a).

Note that the operational mode is not available through the BlueBox (b).

The Signal amplitude bar indicates whether the signal is within the acceptable tolerance (c). Note that prior to performing the Signal Verification process the bar could indicate an out of tolerance signal (d).

Encoder data is displayed in the encoder data area (CAT No., Serial No.) (e).

The position dial display responds to shaft rotation (f).

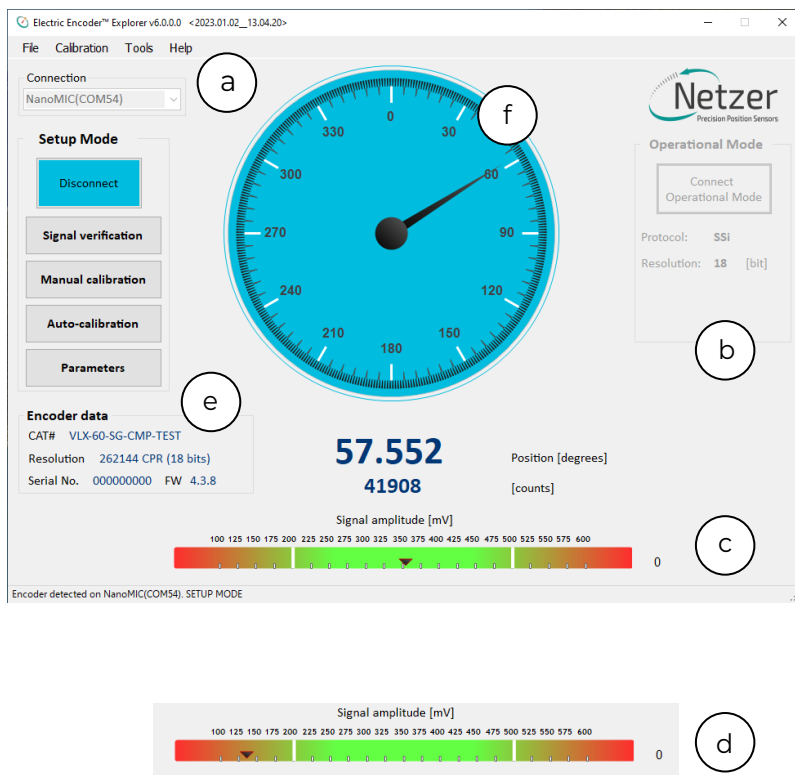

It is important to perform the Signal Verification process prior to the calibration of the encoder to ensure optimal performance.

10.2 Signal verification process

The Signal Verification process ensures that the encoder is mounted correctly and provides good signal amplitudes. This is performed by collecting raw data of the fine and coarse channels during rotation.

- Select <Signal Verification> on the main screen (a).

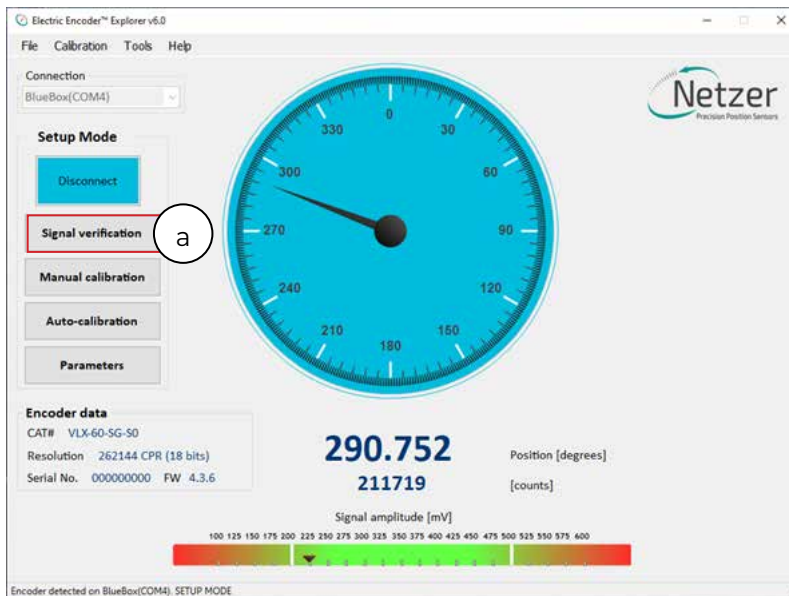

- Select <Start> to initiate the process (b).

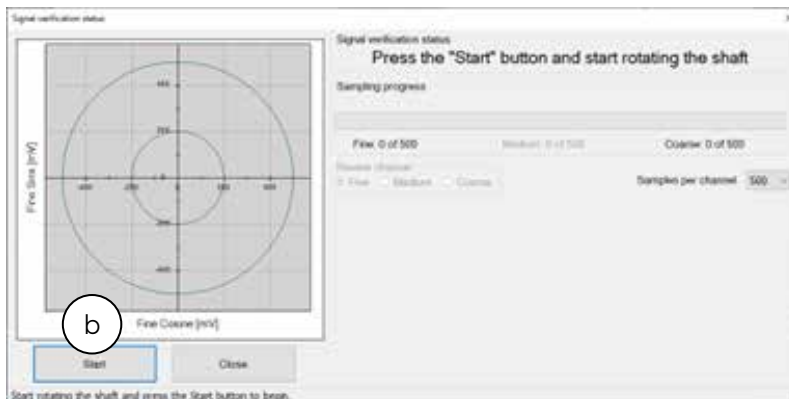

- Rotate the shaft in order to collect the fine and coarse channels data (c).

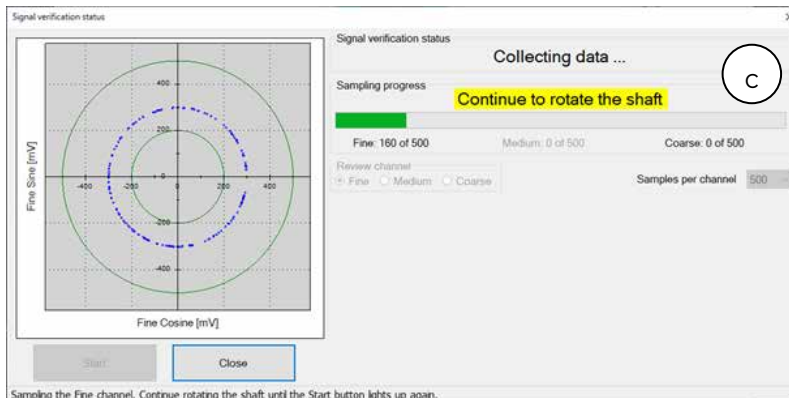

If the process is successful, the status “Signal verification successful” would appear (d). The ‘amplitude circle’ would be centered between the two green circles, preferably in the middle of the tolerance (e).

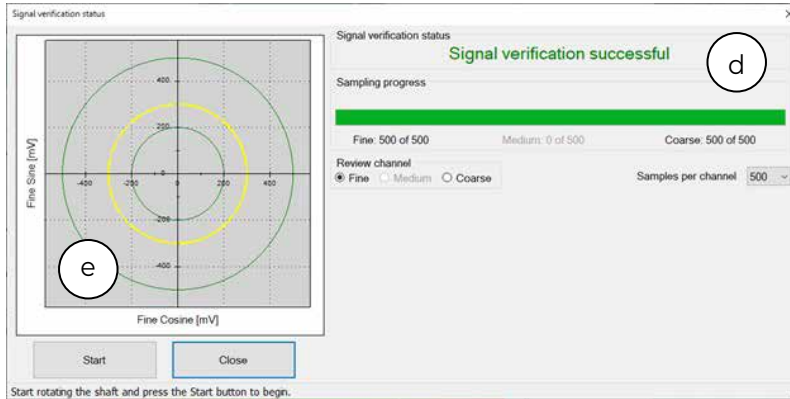

Note: that mounting the encoder towards the extreme mechanical tolerances might cause the amplitude circle to be offset from the exact middle of the nominal position.

If the signal is out of tolerance the Error notification “Amplitude is lower/higher than the min/max limit of XXX” would appear (g).

In Addition, the status “Signal verification failed – remount encoder” would appear at the top (h).

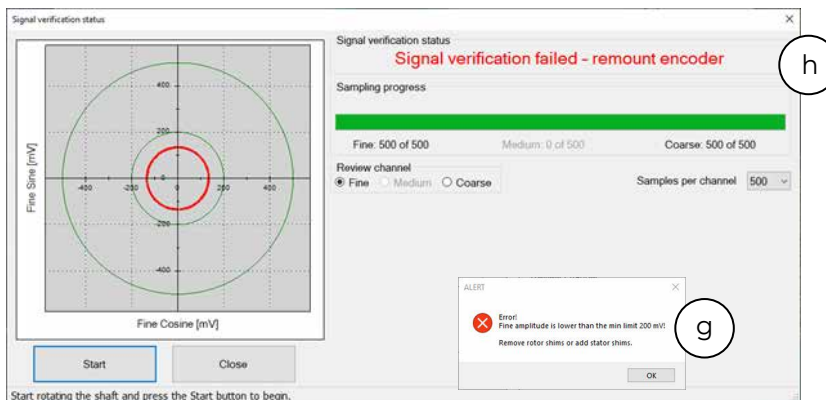

- Stop the process and re-mount the encoder, making sure that the mechanical installation tolerances are not exceeded, removing or adding shims as required.
- Repeat the Signal Verification process after remounting.

Note: Once the signal verification process is successfully completed, proceed to the encoder calibration phase, Section 10.

11. Calibration

It is important that upon every installation of the encoder, the Signal Verification process is completed prior to attempting calibration of the encoder.

For encoders with FW 4 version 4.1.3 or higher, it is possible to select either a fully automated calibration process, or a manual phase-by-phase calibration process.

11.1 Auto-calibration

Auto Calibration is supported by encoders with FW 4 version 4.1.3 or higher.

For these encoders an additional “Auto-calibration” button is displayed.

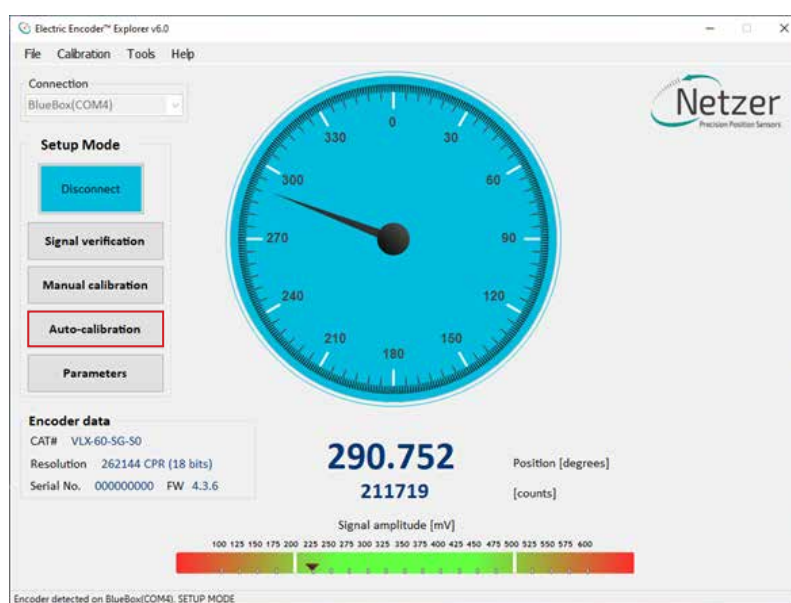

11.1.1 Auto-calibration process

The Auto-calibration process consists of three stages:

1. **Jitter Test – Evaluation of Electrical Noise in Encoder Channels**
The Jitter Test assesses electrical noise levels in the Fine, Medium, and Coarse encoder channels. During this test, the shaft must remain stationary.
Important Notice: The Pass/Fail criteria for the Jitter Test follow strict factory standards. A failure in this test will automatically abort the Auto Calibration process. However, when performed manually as part of the Manual Calibration process (Section 10.3), the user has the flexibility to determine whether the jitter level is acceptable for their specific requirements.
2. **Offset calibration** - to perform the offset calibration, the shaft must rotate continuously throughout the process.
3. **Absolute Position (AP) Calibration** - This step calculates the **Coarse Amplitude Alignment (CAA)** and **Medium Amplitude Alignment (MAA)**. During the Auto-Calibration process, the encoder's Zero Position remains at the factory default for new encoders.

To manually set the Zero Position, navigate to the **Calibration** tab in the top menu bar and select "Set UZP", as described in Section 10.4.

11.1.2 Performing Auto-calibration

Press the <Auto-calibration> button.

The main auto-calibration window opens.

- Select the appropriate measurement range applicable to your application (a).

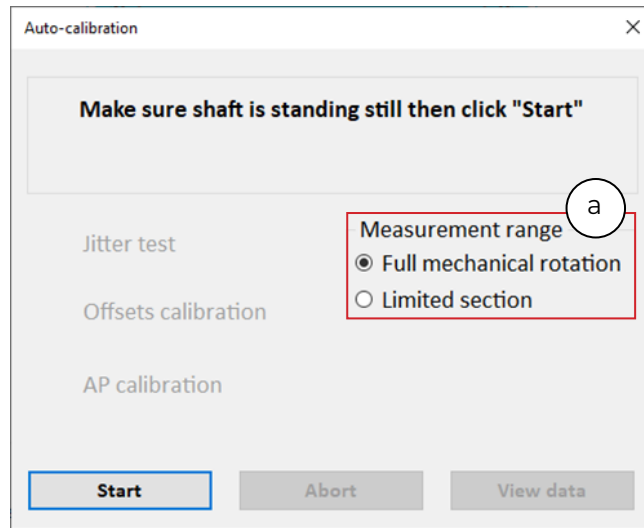

- Make sure to keep the shaft still and press the <Start>

The Noise test would be performed and upon successful completion the “Noise test” label will be marked with a green check mark.

The Offset calibration would automatically start upon completion of the Noise test. This calibration requires that the shaft be rotated continuously.

The AP calibration would automatically start upon completion of the Accuracy Calibration. Continue rotating the shaft in this phase until the AP calibration is completed, and the encoder is reset.

Once the reset is over, the Auto-calibration process is successfully finished.

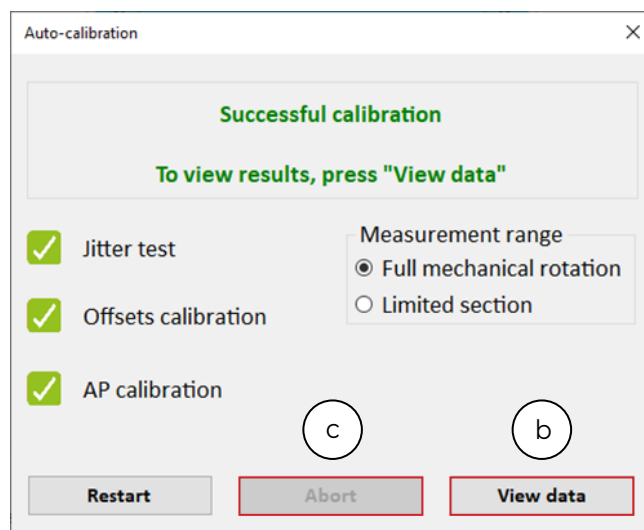

The user can review the calibration results by clicking the <View data> button (b).

Auto-calibration result		
Offsets [mV]		
	Before	After
Fine sine offset	-2.01	-1.87
Fine cosine offset	-0.57	-0.36
Medium sine offset		N/A
Medium cosine offset		N/A
Coarse sine offset	-8.69	-8.62
Coarse cosine offset	16.23	16.23
CAA [electrical degrees]		
	Before calibration	After calibration
CAA	3.52	3.52
MAA		N/A

It is always possible to abort the Auto Calibration process by clicking the <Abort> button (c).

11.1.3 Auto-calibration failures

If a test fails (for example the Noise test) – the result will be marked with in red X.

Calibration failed

✘ Jitter test

Offsets calibration

AP calibration

Measurement range

Full mechanical rotation

Limited section

Restart
Abort
View data

If the calibration process failed, corrective recommendations will be displayed, corresponding to the element which had failed the test.

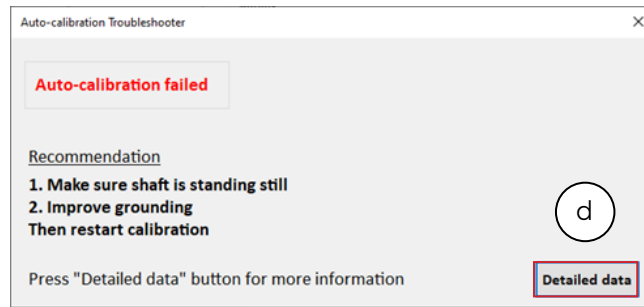

It is possible to review detailed information regarding the failure, by clicking the <Detailed data> button (d).

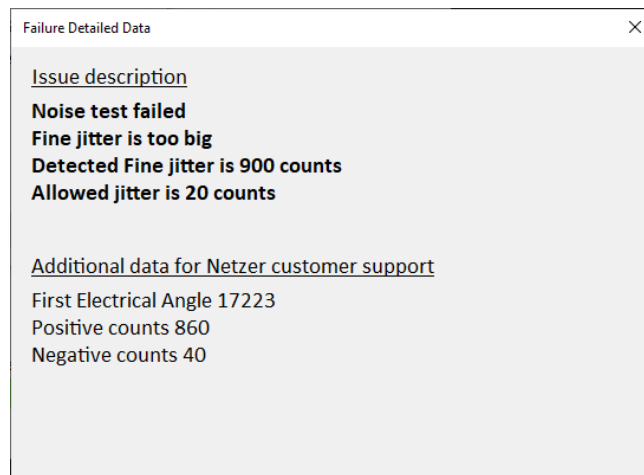

11.2 Manual calibration

The Manual calibration process consists of the following stages:

1. **Offset calibration** - performs the offset calibration, the shaft must rotate continuously.
2. **CAA / MAA Calibration** - performs Coarse Amplitude Alignment (CAA) and Medium Amplitude Alignment (MAA) are calculated.
3. **Zero Position Set** - Used to determine a Zero Position other than the factory default.
4. **Jitter Test** - Used to determine the amount of jitter and allow the user to decide if acceptable.

- Select <Manual Calibration> on the main screen (a).

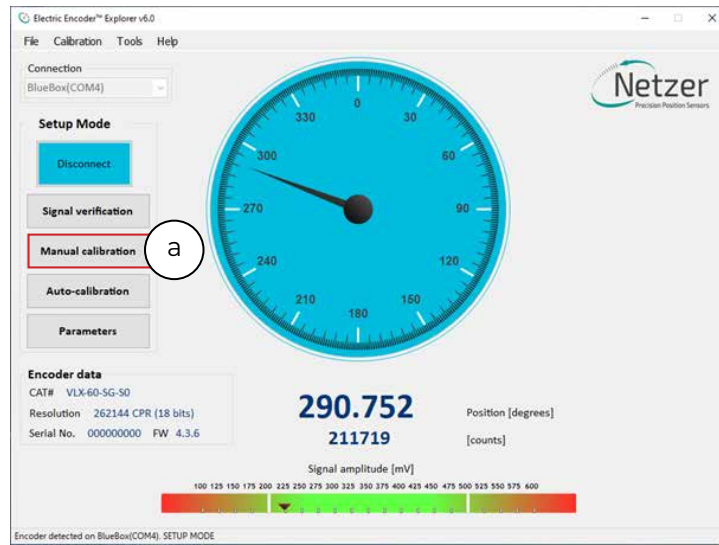

11.2.1 Offset calibration

In this process, the DC (direct current) offset of the sine and cosine signals are compensated over the operational sector (offset calibration).

- Click <Start data acquisition> (b).
- Rotate the shaft continuously during data collection, covering the whole working sector of the application from end to end. The progress bar (c) indicates the progress of the data collection.

Rotation speed is not a parameter during data collection. By default, the procedure collects 500 points. The collected data for the fine / coarse channels, should be a clear "thin" circle which appears in the center of the plots (d) (e) with a possible slight offset.

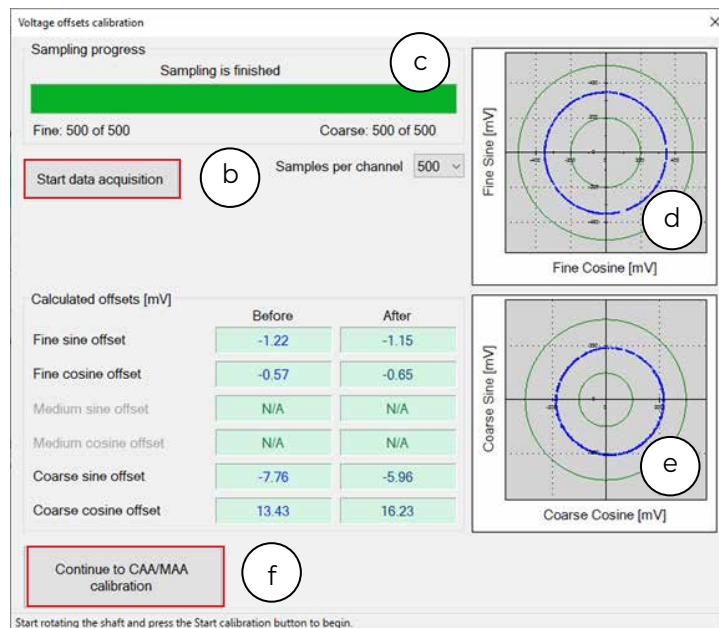

- When offset calibration is completed, click on <Continue to CAA/MAA Calibration> button (f).

11.2.2 Calibration of Coarse Amplitude Alignment (CAA) & Medium Amplitude Alignment (MAA)

The following calibration aligns the coarse channel, and medium channel in certain encoders, with the fine channel by collecting data from each point in both channels. This is performed to make sure that every time the encoder is turned on, it would provide an accurate absolute position.

- Select the relevant option from the Measurement Range options (a):
 - Full mechanical rotation** - shaft movement is over a full 360 degrees rotation – (that is the recommended calibration).
 - Limited section** - shaft has a limited rotation angle which is less than 360 degrees. In that mode you need to input the rotation range by degrees.
 - Free sampling mode** - sets the number of calibration points in accordance with the total number of points in the text box. The system displays the recommended number of points by default. The minimum points over the working sector are nine.

Note that the Total number of points would change to the optimal default according to the selected measurement range above.

- Click the <Start Calibration> button (b).

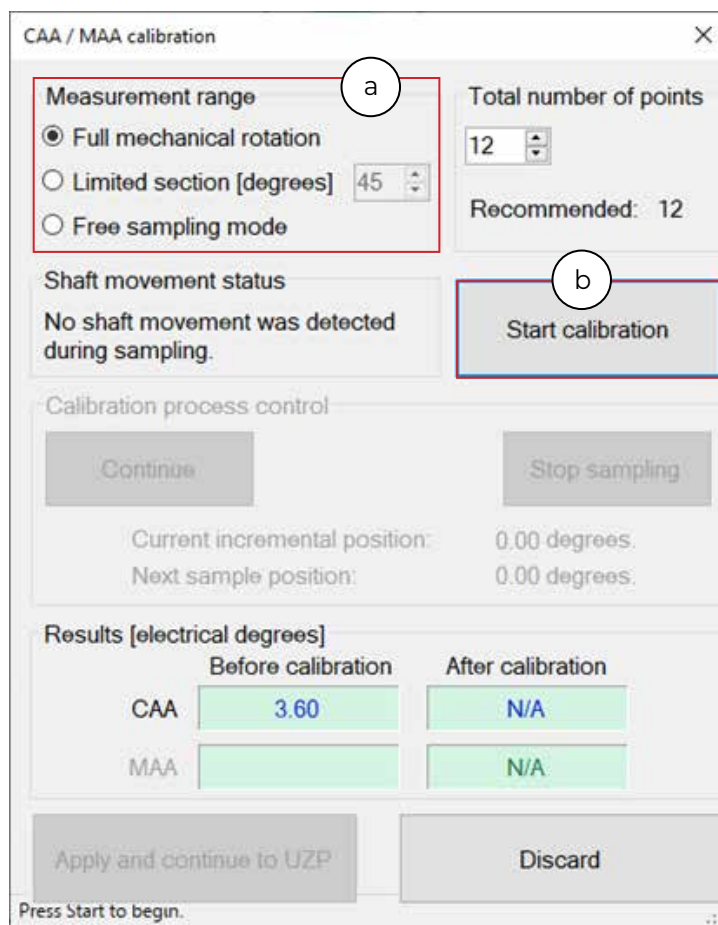

The Calibration process control (c) indicates the current position, and the next target position to which the shaft should be rotated.

- Rotate the shaft to the next position, stop and click the <Continue> button to sample the position (d).
The shaft should be at STAND STILL when clicking the button.

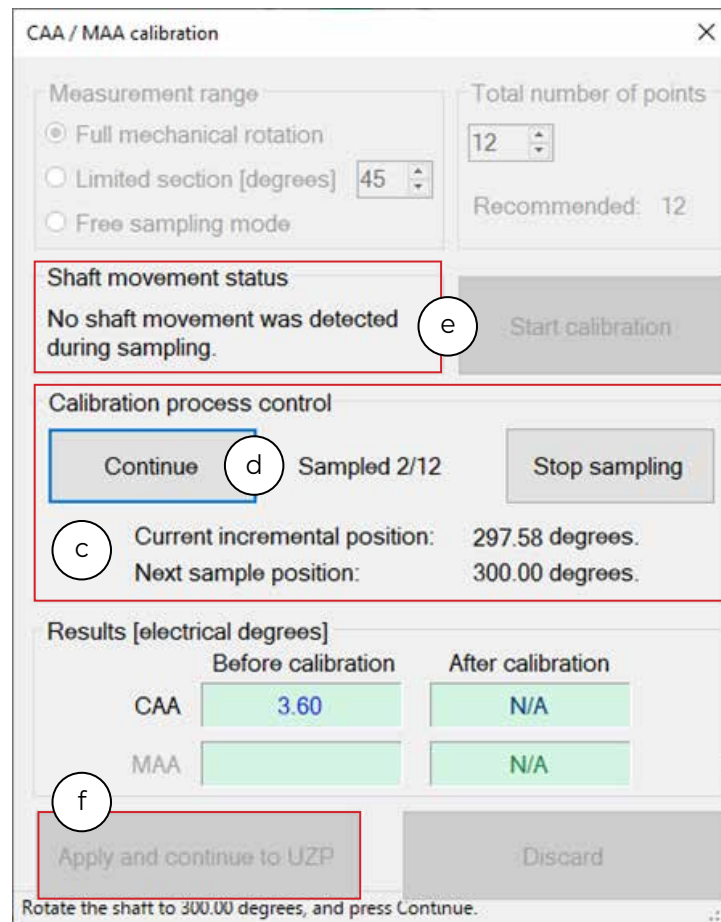

The Shaft movement status (e) indicates the shaft movement status.

- Complete the sampling process using the following routine: positioning the shaft --> stand still --> clicking <Continue> (d) to sample the position.
- When the process is completed click the <Apply and Continue to UZP> button (f).

11.3 Setting the zero-position of the encoder

- Select one of the options for setting the zero point and click <Apply and close>.

It is possible to set either current position or rotate the shaft to any other position to be set as the zero point.

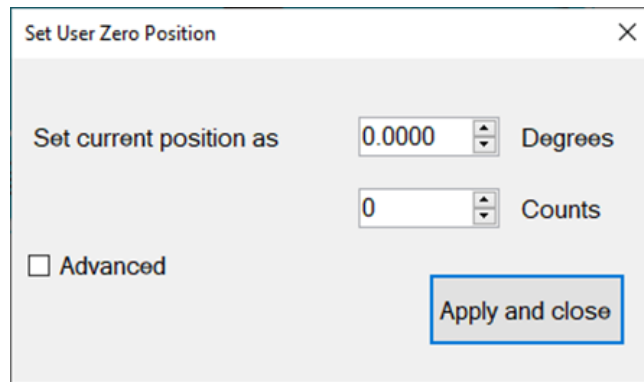

It is also possible to set the Zero Point through the top menu bar, by selecting “Calibration” tab, and clicking “Set UZP”.

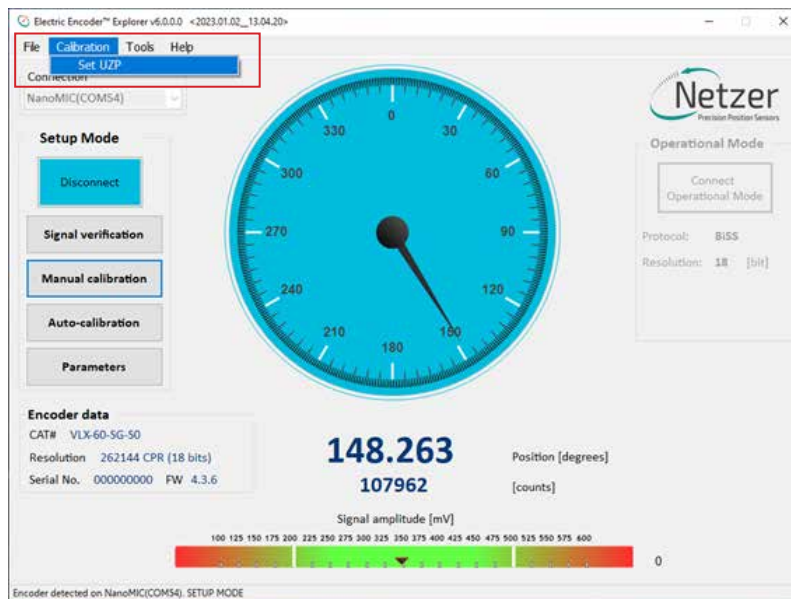

11.4 Jitter test

The jitter test is used evaluate the level of electric noise.

Common jitter should be +/- 3 counts; higher jitter may indicate system noise and would require better grounding or shielding of the electric noise source.

- Select “Calibration” tab, and click “Jitter Test”

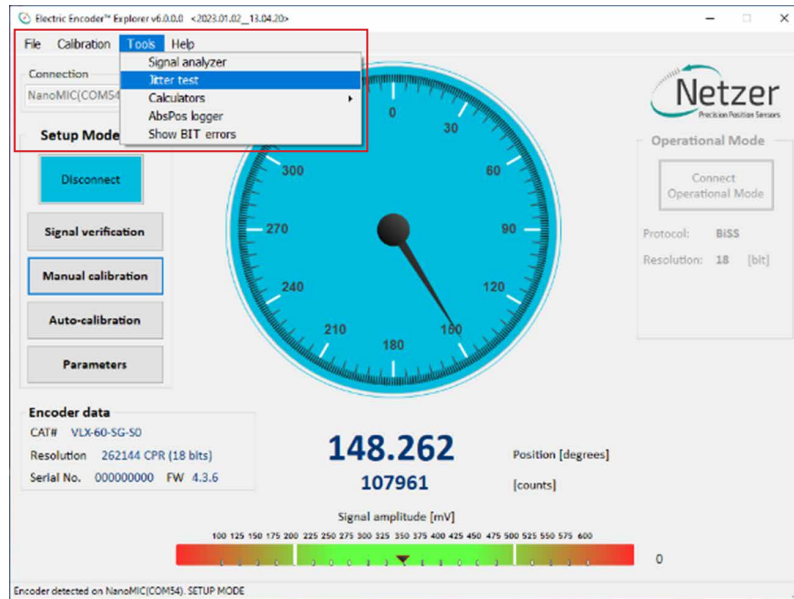

- Select the Jitter test mode (a).
- Set the Timing and Sampling parameters (b).
- Click <Start> button (c) and check if the results (d) are within acceptable tolerances for the intended application.

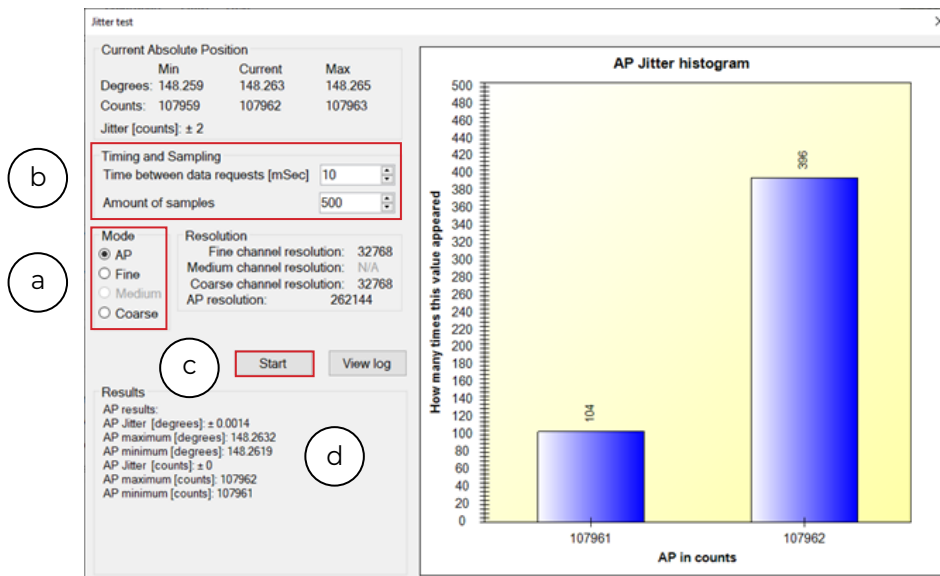

Another indication of excessive jitter/noise when the blue dots in signal amplitude circle are not evenly distributed on a thin circle as appears below.

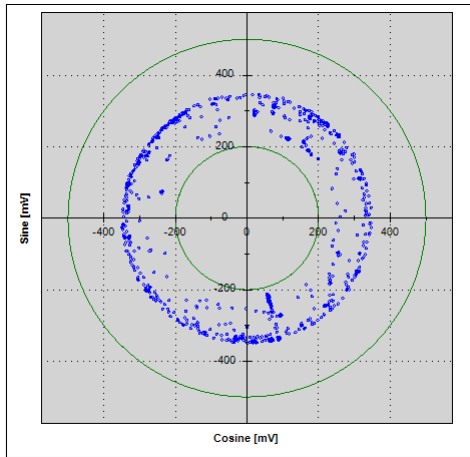

Excessive jitter/noise

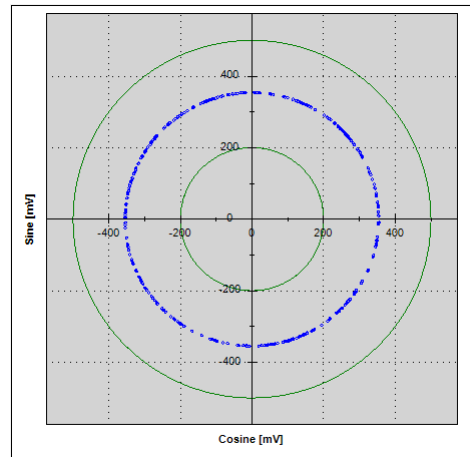

Low jitter/noise

12. Operational Mode

12.1 SSI / BiSS

Operational Mode indication of the SSI / BiSS encoder interface is available by using the NanoMIC to connect with the encoder. When in Operational Mode the color of the position dial is orange.

[For more information read about NanoMIC on Netzer website](#)

The operational mode is using SSI / BiSS interface with 1MHz clock rate.

The encoder position-dial is colored orange when in Operational Mode. The bar below the dial, is the corresponding binary word output for the current shaft position (a).

SSI Protocol

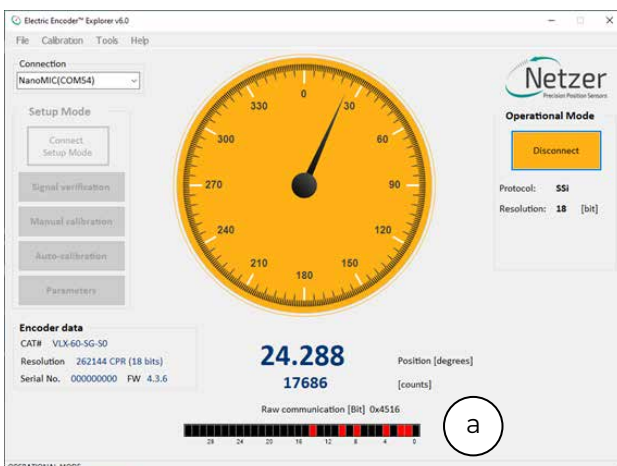

BiSS Protocol

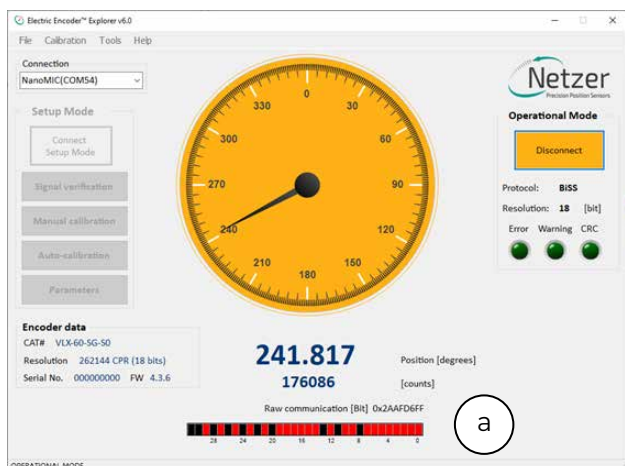



ISRAEL

Netzer Precision Position Sensors A.C.S. Ltd.
Misgav Industrial Park, P.O. Box 1359
Misgav, 2017400
Tel: +972 4 999 0420

USA

Netzer Precision Position Sensors Inc.
250 Commercial Street, Suite 3008
Manchester, NH 03101
Tel: +1 617 901 0820



VLP-PG-V02-2

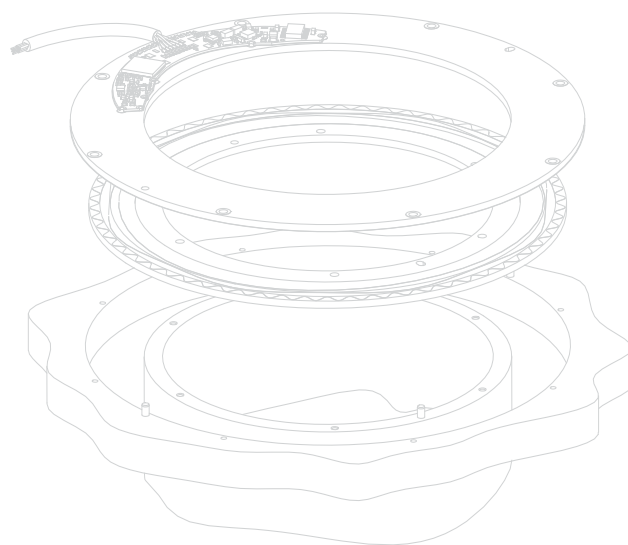

SCAN HERE

